

Flachau 40 (300x300)

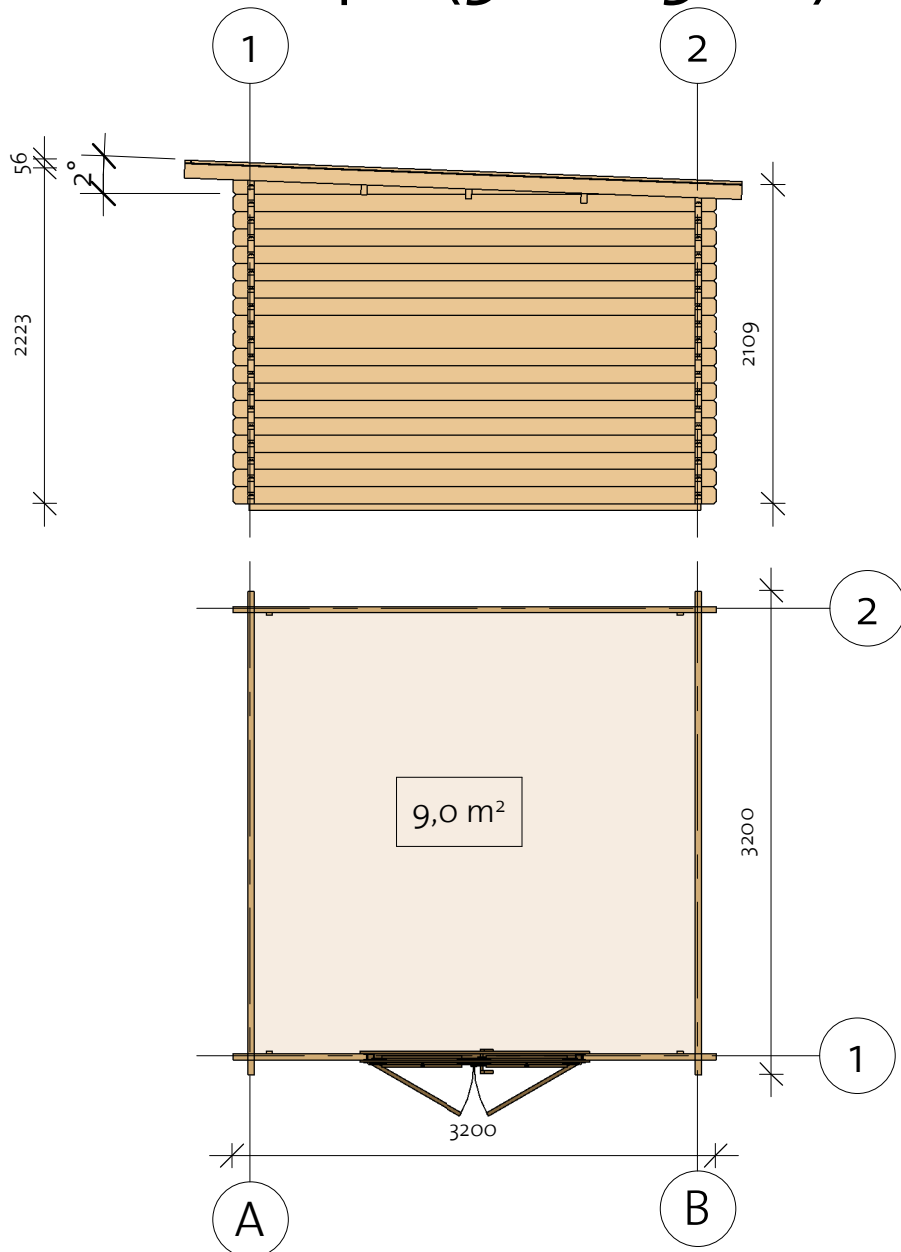



92111920_210126

 **VIKTRÄ**

Flachau 40 (300x300)

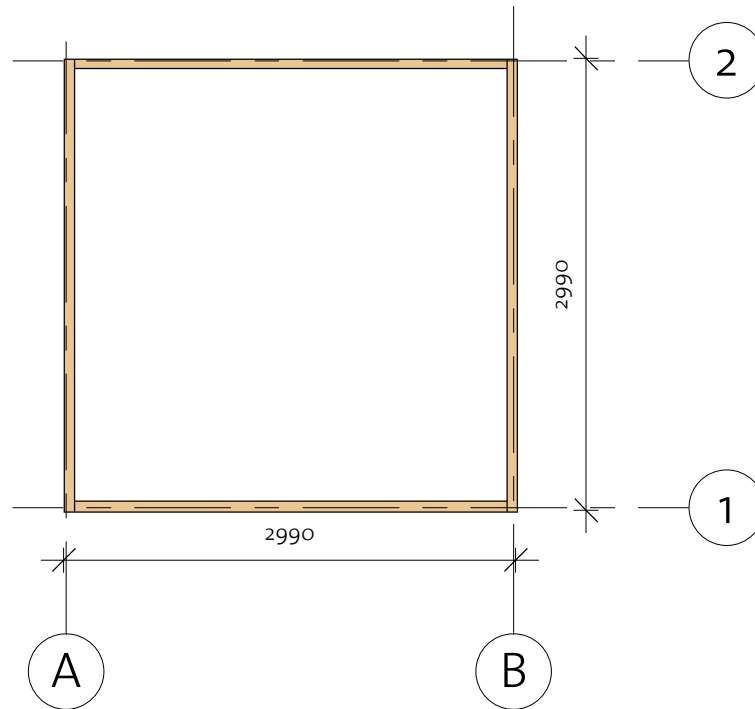
Foundation



Impregnated foundation beams				
Mark	Type	Profile	Count	Length
IFB1	IFB 70x40		2	2990
IFB2	IFB 70x40		2	2850

Flachau 40 (300x300)

Wall 1

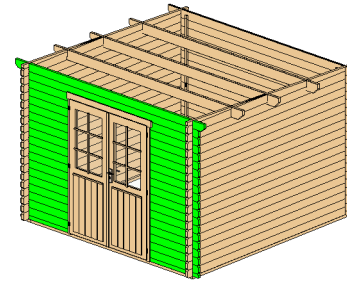

Wall 1			
Mark	Profile	Count	Cut Length

1BL-1	40x57	2	880
1LG-1	40x114	34	880
1LG-2	40x114	1	3200
1TL-1	40x114	1	3400

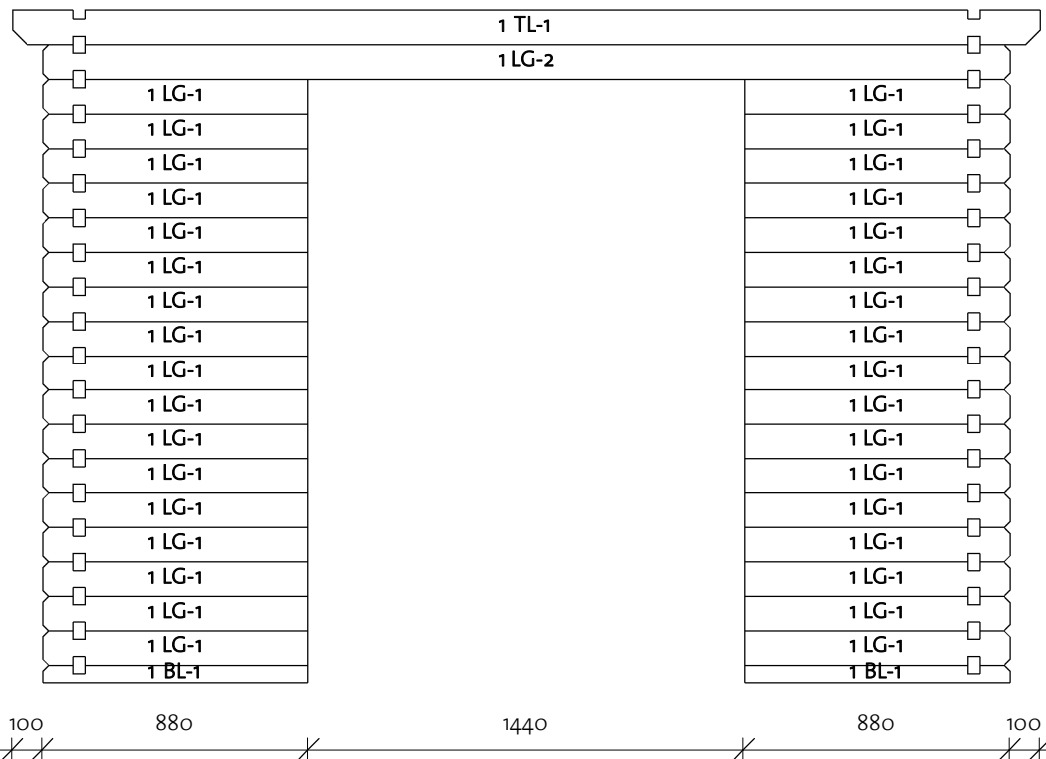

Log Profile Wall 1	
Profile	Profile

40x57	
40x114	
40x114	

92111920_210126

Flachau 40 (300x300)

Wall 2

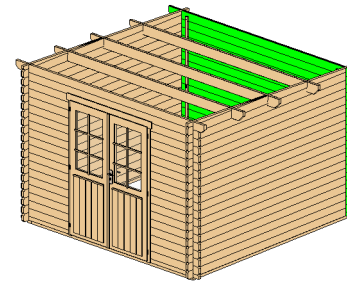

Wall 2			
Mark	Profile	Count	Cut Length
2BL-1	40x57	1	3200
2LG-1	40x114	17	3200
2TL-1	40x114	1	3400

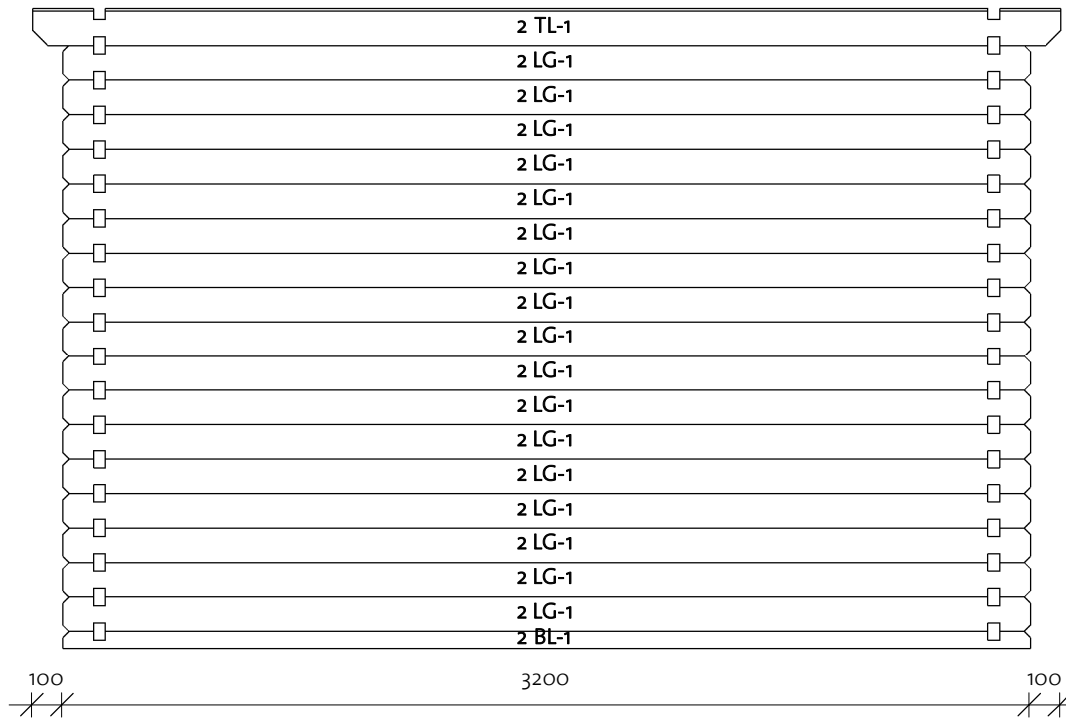

Log Profile Wall 2	
Profile	Profile

40x57	
40x114	
40x114	

Flachau 40 (300x300)

Wall A

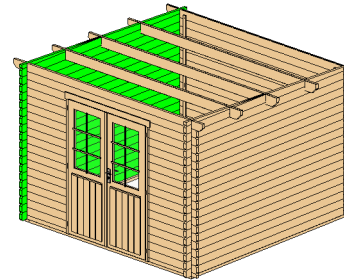

Wall A			
Mark	Profile	Count	Cut Length

ALG-1	40X114	17	3200
ALG-2*	40X114	1	3200
ALG-3*	40X114	1	3200
ALG-4*	40X114	1	1550

* Gable - delivered premounted

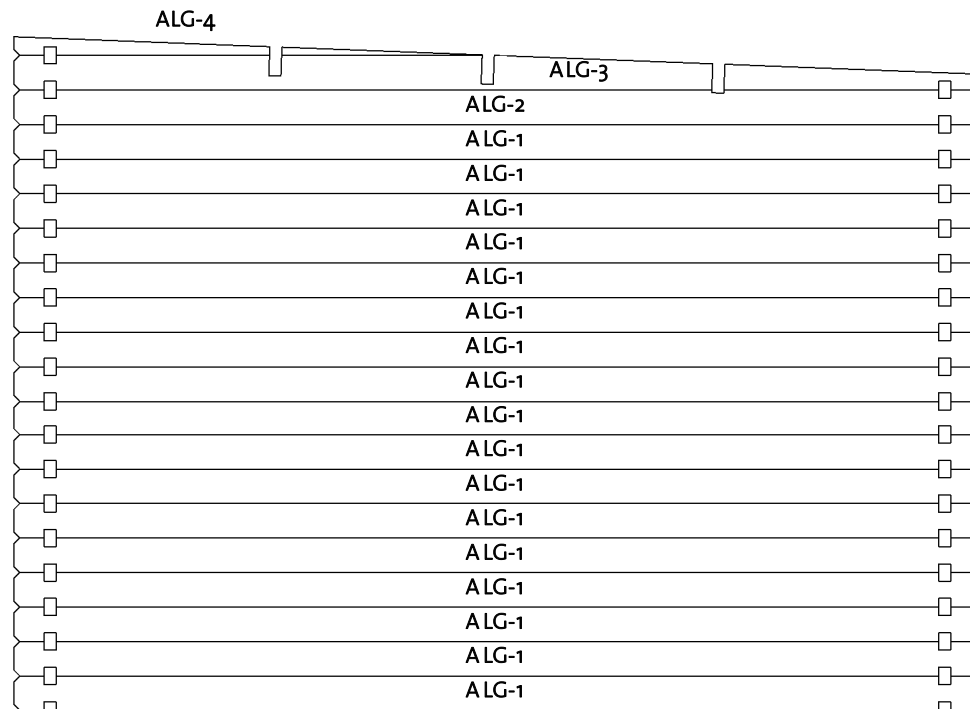

Log Profile Wall A	
Profile	Profile

40X114	
--------	--

Flachau 40 (300x300)

Wall B

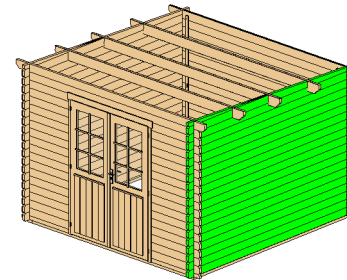

Wall B			
Mark	Profile	Count	Cut Length

BLG-1	40X114	17	3200
BLG-2*	40X114	1	3200
BLG-3*	40X114	1	3200
BLG-4*	40X114	1	1550

* Gable - delivered premounted

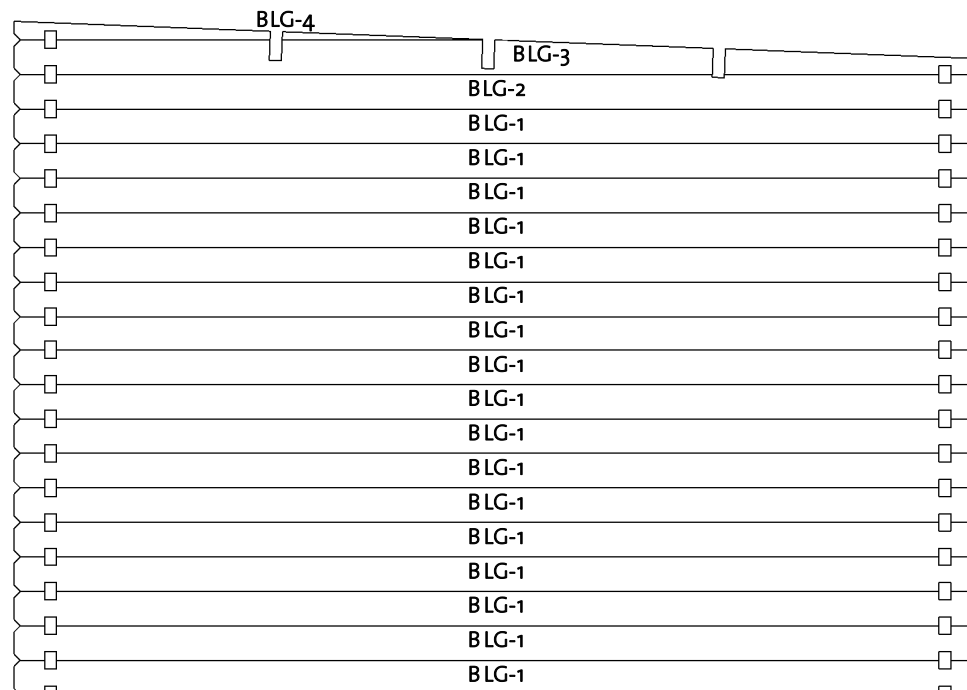



Log Profile Wall B	
Profile	Profile

40X114	
--------	--

Flachau 40 (300x300)

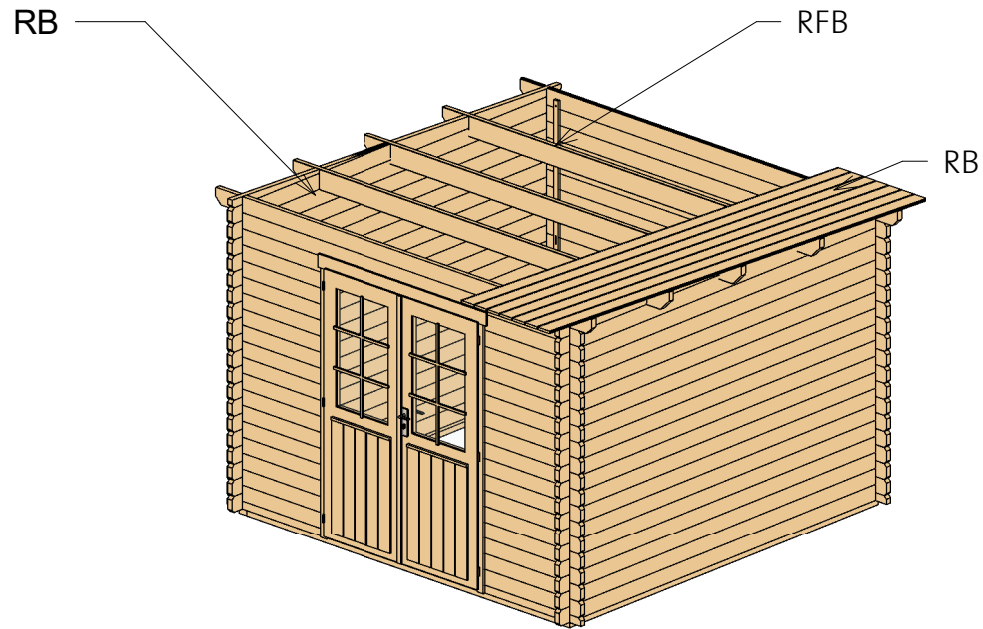
Roof 1



Roof				
Mark	Type	Profile	Count	Length
RFB	Beam 40x143		3	3400
RB	17x114		31	3652

Flachau 40 (300x300)

Roof 2

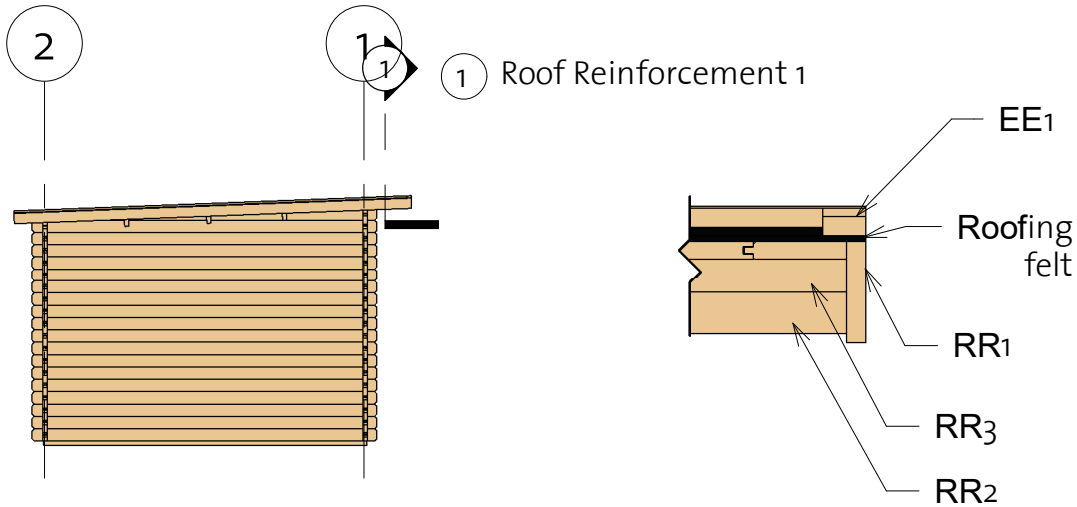

2 Roof Reinforcement 2

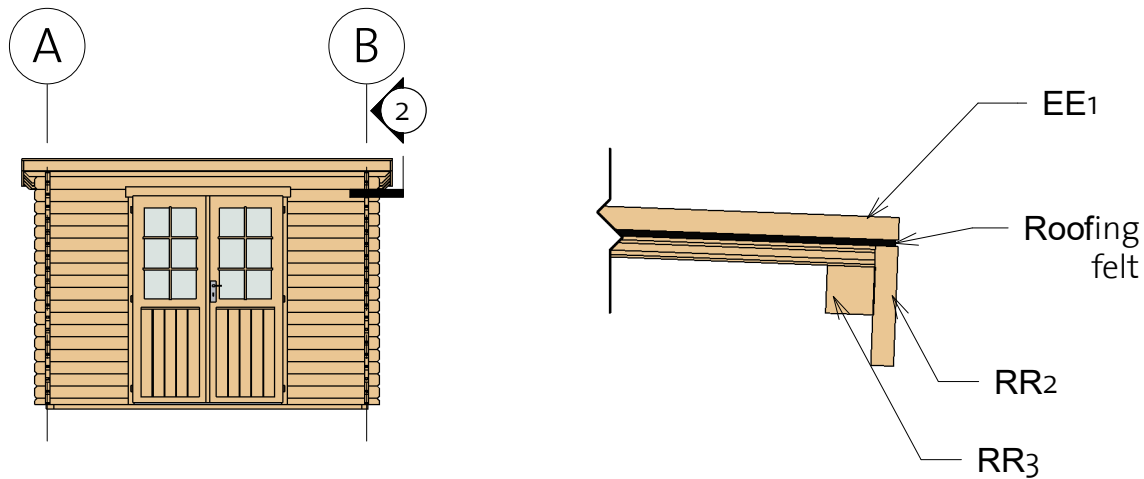

Fascia Schedule				
Mark	Type	Profile	Count	Length
EE1	Eave Edging 18x40		2	3648
EE2	Eave Edging 18x40		1	3436
RR1	Roof reinforcement 18x95		2	3689
RR2	Roof reinforcement 18x95		2	3400
RR3	Roof reinforcement 38x38		2	3400

Flachau 40 (300x300)

Extras

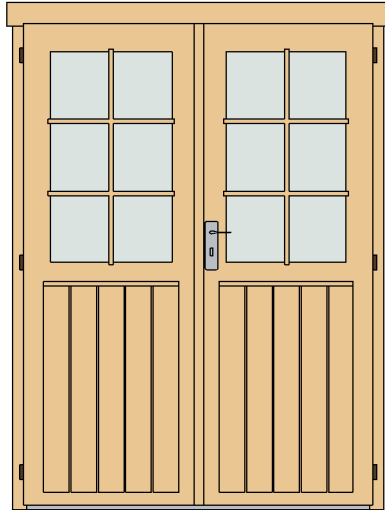

Door Schedule				
Mark	Type	Width	Height	Count
CDD1R	Classic double door 1 right	1425	1955	1
DCB6	Door Crossbar 6	--	--	2

Fasteners & Extras		
Name	Type	Count

Hitblock	300-400 mm	
Screws	5,0 x 70	10
Bolts	M8 x 70	12
Screws	6,0 x 140	25
Screws	4,0 x 40	70
Screws	4,0 x 50	180







Windboard Schedule		
Type	Count	Length





Windboard 18x40	4	2200
--------------------	---	------

Flachau 40 (300x300)

List of all items 1

Impregnated foundation beams				
Mark	Type	Profile	Count	Length
IFB1	IFB 70x40		2	2990
IFB2	IFB 70x40		2	2850

Roof				
Mark	Type	Profile	Count	Length
RFB	Beam 40x143		3	3400
RB	17x114		31	3652

Fascia Schedule				
Mark	Type	Profile	Count	Length
EE1	Eave Edging 18x40		2	3648
EE2	Eave Edging 18x40		1	3436
RR1	Roof reinforcement 18x95		2	3689
RR2	Roof reinforcement 18x95		2	3400
RR3	Roof reinforcement 38x38		2	3400

Flachau 40 (300x300)

List of all items 2

Wall 1			
Mark	Profile	Count	Cut Length

1BL-1	40x57	2	880
1LG-1	40x114	34	880
1LG-2	40x114	1	3200
1TL-1	40x114	1	3400

Wall 2			
Mark	Profile	Count	Cut Length

2BL-1	40x57	1	3200
2LG-1	40x114	17	3200
2TL-1	40x114	1	3400

Wall A			
Mark	Profile	Count	Cut Length



ALG-1	40x114	17	3200
ALG-2*	40x114	1	3200
ALG-3*	40x114	1	3200
ALG-4*	40x114	1	1550

Wall B			
Mark	Profile	Count	Cut Length

BLG-1	40x114	17	3200
BLG-2*	40x114	1	3200
BLG-3*	40x114	1	3200
BLG-4*	40x114	1	1550

* Gable - delivered premounted

Log Profiles	
Profile	Profile

40x57	
40x114	

Log Profiles	
Profile	Profile

40x114	
--------	---------------------------------------------------------------------------------------